

The University of the State of New York  
REGENTS HIGH SCHOOL EXAMINATION

# GEOMETRY (Common Core)

Wednesday, August 17, 2016 — 8:30 to 11:30 a.m., only

Student Name: \_\_\_\_\_

School Name: \_\_\_\_\_

The possession or use of any communications device is strictly prohibited when taking this examination. If you have or use any communications device, no matter how briefly, your examination will be invalidated and no score will be calculated for you.

Print your name and the name of your school on the lines above.

A separate answer sheet for Part I has been provided to you. Follow the instructions from the proctor for completing the student information on your answer sheet.

This examination has four parts, with a total of 36 questions. You must answer all questions in this examination. Record your answers to the Part I multiple-choice questions on the separate answer sheet. Write your answers to the questions in Parts II, III, and IV directly in this booklet. All work should be written in pen, except for graphs and drawings, which should be done in pencil. Clearly indicate the necessary steps, including appropriate formula substitutions, diagrams, graphs, charts, etc. Utilize the information provided for each question to determine your answer. Note that diagrams are not necessarily drawn to scale.

The formulas that you may need to answer some questions in this examination are found at the end of the examination. This sheet is perforated so you may remove it from this booklet.

Scrap paper is not permitted for any part of this examination, but you may use the blank spaces in this booklet as scrap paper. A perforated sheet of scrap graph paper is provided at the end of this booklet for any question for which graphing may be helpful but is not required. You may remove this sheet from this booklet. Any work done on this sheet of scrap graph paper will *not* be scored.

When you have completed the examination, you must sign the statement printed at the end of the answer sheet, indicating that you had no unlawful knowledge of the questions or answers prior to the examination and that you have neither given nor received assistance in answering any of the questions during the examination. Your answer sheet cannot be accepted if you fail to sign this declaration.

Notice...

A graphing calculator, a straightedge (ruler), and a compass must be available for you to use while taking this examination.

DO NOT OPEN THIS EXAMINATION BOOKLET UNTIL THE SIGNAL IS GIVEN.

## Part I

Answer all 24 questions in this part. Each correct answer will receive 2 credits. No partial credit will be allowed. Utilize the information provided for each question to determine your answer. Note that diagrams are not necessarily drawn to scale. For each statement or question, choose the word or expression that, of those given, best completes the statement or answers the question. Record your answers on your separate answer sheet. [48]

1 In the diagram below, lines  $\ell$ ,  $m$ ,  $n$ , and  $p$  intersect line  $r$ .

Use this space for computations.

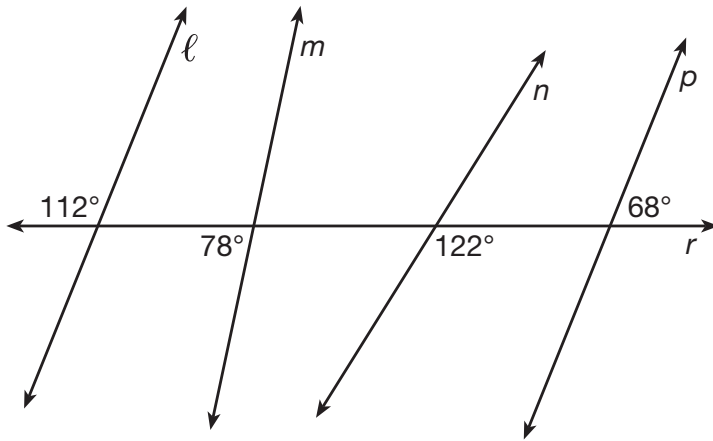

Which statement is true?

- (1)  $\ell \parallel n$
- (2)  $\ell \parallel p$
- (3)  $m \parallel p$
- (4)  $m \parallel n$

2 Which transformation would *not* always produce an image that would be congruent to the original figure?

- (1) translation
- (2) dilation
- (3) rotation
- (4) reflection

3 If an equilateral triangle is continuously rotated around one of its medians, which 3-dimensional object is generated?

- (1) cone
- (2) pyramid
- (3) prism
- (4) sphere

Use this space for computations.

- 4 In the diagram below,  $m\angle BDC = 100^\circ$ ,  $m\angle A = 50^\circ$ , and  $m\angle DBC = 30^\circ$ .

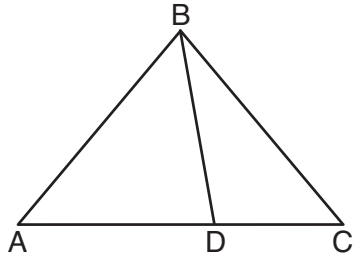

Which statement is true?

- (1)  $\triangle ABD$  is obtuse.                      (3)  $m\angle ABD = 80^\circ$   
(2)  $\triangle ABC$  is isosceles.                (4)  $\triangle ABD$  is scalene.
- 5 Which point shown in the graph below is the image of point  $P$  after a counterclockwise rotation of  $90^\circ$  about the origin?

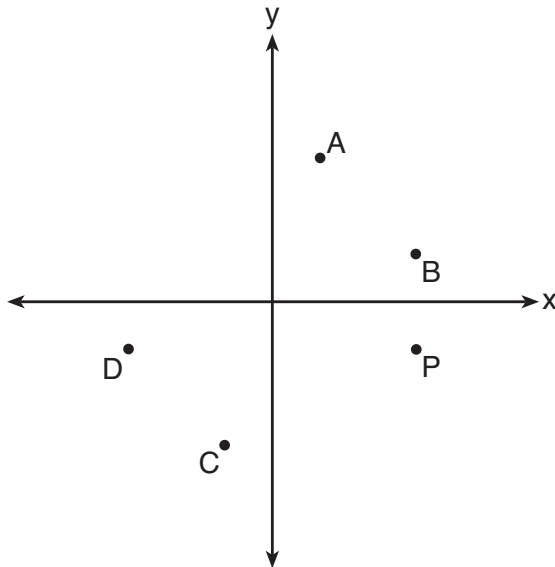

- (1)  $A$     (3)  $C$   
(2)  $B$     (4)  $D$

Use this space for computations.

6 In  $\triangle ABC$ , where  $\angle C$  is a right angle,  $\cos A = \frac{\sqrt{21}}{5}$ . What is  $\sin B$ ?

(1)  $\frac{\sqrt{21}}{5}$

(3)  $\frac{2}{5}$

(2)  $\frac{\sqrt{21}}{2}$

(4)  $\frac{5}{\sqrt{21}}$

7 Quadrilateral  $ABCD$  with diagonals  $\overline{AC}$  and  $\overline{BD}$  is shown in the diagram below.

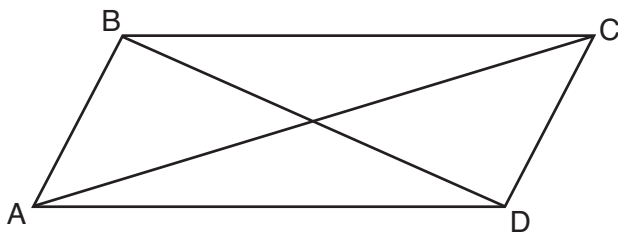

Which information is *not* enough to prove  $ABCD$  is a parallelogram?

(1)  $\overline{AB} \cong \overline{CD}$  and  $\overline{AB} \parallel \overline{DC}$

(2)  $\overline{AB} \cong \overline{CD}$  and  $\overline{BC} \cong \overline{DA}$

(3)  $\overline{AB} \cong \overline{CD}$  and  $\overline{BC} \parallel \overline{AD}$

(4)  $\overline{AB} \parallel \overline{DC}$  and  $\overline{BC} \parallel \overline{AD}$

8 An equilateral triangle has sides of length 20. To the *nearest tenth*, what is the height of the equilateral triangle?

(1) 10.0

(3) 17.3

(2) 11.5

(4) 23.1

Use this space for computations.

9 Given:  $\triangle AEC$ ,  $\triangle DEF$ , and  $\overline{FE} \perp \overline{CE}$

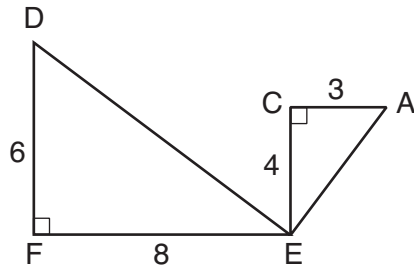

What is a correct sequence of similarity transformations that shows  $\triangle AEC \sim \triangle DEF$ ?

- (1) a rotation of 180 degrees about point  $E$  followed by a horizontal translation
- (2) a counterclockwise rotation of 90 degrees about point  $E$  followed by a horizontal translation
- (3) a rotation of 180 degrees about point  $E$  followed by a dilation with a scale factor of 2 centered at point  $E$
- (4) a counterclockwise rotation of 90 degrees about point  $E$  followed by a dilation with a scale factor of 2 centered at point  $E$

10 In the diagram of right triangle  $ABC$ ,  $\overline{CD}$  intersects hypotenuse  $\overline{AB}$  at  $D$ .

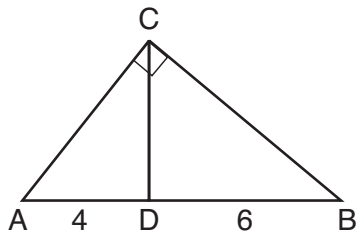

If  $AD = 4$  and  $DB = 6$ , which length of  $\overline{AC}$  makes  $\overline{CD} \perp \overline{AB}$ ?

- |                  |                  |
|------------------|------------------|
| (1) $2\sqrt{6}$  | (3) $2\sqrt{15}$ |
| (2) $2\sqrt{10}$ | (4) $4\sqrt{2}$  |

Use this space for  
computations.

11 Segment  $CD$  is the perpendicular bisector of  $\overline{AB}$  at  $E$ . Which pair of segments does *not* have to be congruent?

- (1)  $\overline{AD}, \overline{BD}$                       (3)  $\overline{AE}, \overline{BE}$   
(2)  $\overline{AC}, \overline{BC}$                       (4)  $\overline{DE}, \overline{CE}$

12 In triangle  $CHR$ ,  $O$  is on  $\overline{HR}$ , and  $D$  is on  $\overline{CR}$  so that  $\angle H \cong \angle RDO$ .

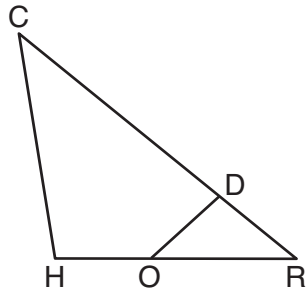

If  $RD = 4$ ,  $RO = 6$ , and  $OH = 4$ , what is the length of  $\overline{CD}$ ?

- (1)  $2\frac{2}{3}$                                       (3) 11  
(2)  $6\frac{2}{3}$                                       (4) 15

13 The cross section of a regular pyramid contains the altitude of the pyramid. The shape of this cross section is a

- (1) circle                                      (3) triangle  
(2) square                                      (4) rectangle

14 The diagonals of rhombus  $TEAM$  intersect at  $P(2,1)$ . If the equation of the line that contains diagonal  $\overline{TA}$  is  $y = -x + 3$ , what is the equation of a line that contains diagonal  $\overline{EM}$ ?

- (1)  $y = x - 1$                               (3)  $y = -x - 1$   
(2)  $y = x - 3$                               (4)  $y = -x - 3$



**Use this space for  
computations.**

**18** Point  $P$  is on the directed line segment from point  $X(-6, -2)$  to point  $Y(6, 7)$  and divides the segment in the ratio 1:5. What are the coordinates of point  $P$ ?

- (1)  $(4, 5\frac{1}{2})$                       (3)  $(-4\frac{1}{2}, 0)$   
(2)  $(-\frac{1}{2}, -4)$                       (4)  $(-4, -\frac{1}{2})$

**19** In circle  $O$ , diameter  $\overline{AB}$ , chord  $\overline{BC}$ , and radius  $\overline{OC}$  are drawn, and the measure of arc  $BC$  is  $108^\circ$ .

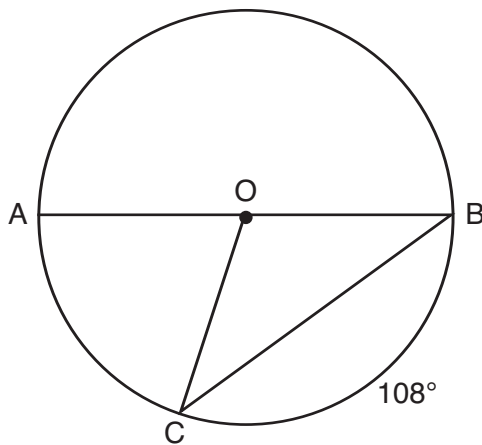

Some students wrote these formulas to find the area of sector  $COB$ :

Amy  $\frac{3}{10} \cdot \pi \cdot (BC)^2$

Beth  $\frac{108}{360} \cdot \pi \cdot (OC)^2$

Carl  $\frac{3}{10} \cdot \pi \cdot (\frac{1}{2}AB)^2$

Dex  $\frac{108}{360} \cdot \pi \cdot \frac{1}{2}(AB)^2$

Which students wrote correct formulas?

- (1) Amy and Dex                      (3) Carl and Amy  
(2) Beth and Carl                      (4) Dex and Beth



Use this space for  
computations.

20 Tennis balls are sold in cylindrical cans with the balls stacked one on top of the other. A tennis ball has a diameter of 6.7 cm. To the nearest cubic centimeter, what is the minimum volume of the can that holds a stack of 4 tennis balls?

- (1) 236                                      (3) 564  
(2) 282                                      (4) 945

21 Line segment  $\overline{A'B'}$ , whose endpoints are  $(4, -2)$  and  $(16, 14)$ , is the image of  $\overline{AB}$  after a dilation of  $\frac{1}{2}$  centered at the origin. What is the length of  $\overline{AB}$ ?

- (1) 5    (3) 20  
(2) 10    (4) 40

22 Given:  $\triangle ABE$  and  $\triangle CBD$  shown in the diagram below with  $\overline{DB} \cong \overline{BE}$

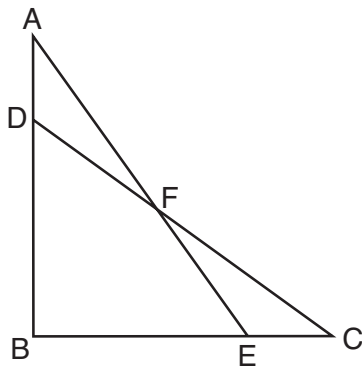

Which statement is needed to prove  $\triangle ABE \cong \triangle CBD$  using only SAS  $\cong$  SAS?

- (1)  $\angle CDB \cong \angle AEB$                       (3)  $\overline{AD} \cong \overline{CE}$   
(2)  $\angle AFD \cong \angle EFC$                     (4)  $\overline{AE} \cong \overline{CD}$

23 In the diagram below,  $\overline{BC}$  is the diameter of circle A.

Use this space for  
computations.

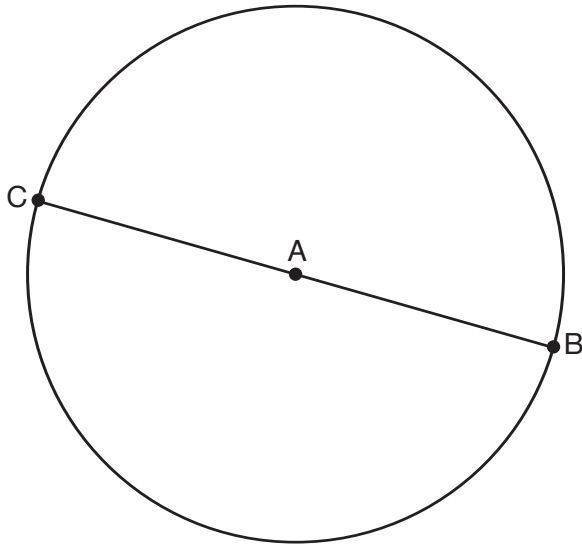

Point  $D$ , which is unique from points  $B$  and  $C$ , is plotted on circle A. Which statement must always be true?

- (1)  $\triangle BCD$  is a right triangle.
- (2)  $\triangle BCD$  is an isosceles triangle.
- (3)  $\triangle BAD$  and  $\triangle CBD$  are similar triangles.
- (4)  $\triangle BAD$  and  $\triangle CAD$  are congruent triangles.

24 In the diagram below,  $ABCD$  is a parallelogram,  $\overline{AB}$  is extended through  $B$  to  $E$ , and  $\overline{CE}$  is drawn.

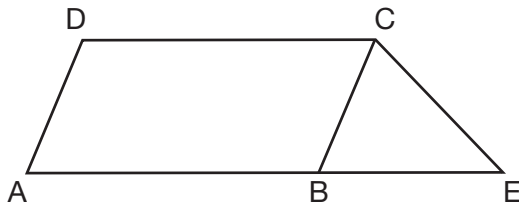

If  $\overline{CE} \cong \overline{BE}$  and  $m\angle D = 112^\circ$ , what is  $m\angle E$ ?

- (1)  $44^\circ$
- (2)  $56^\circ$
- (3)  $68^\circ$
- (4)  $112^\circ$

## Part II

Answer all 7 questions in this part. Each correct answer will receive 2 credits. Clearly indicate the necessary steps, including appropriate formula substitutions, diagrams, graphs, charts, etc. Utilize the information provided for each question to determine your answer. Note that diagrams are not necessarily drawn to scale. For all questions in this part, a correct numerical answer with no work shown will receive only 1 credit. All answers should be written in pen, except for graphs and drawings, which should be sec done in pencil. [14]

- 25 Lines  $AE$  and  $BD$  are tangent to circles  $O$  and  $P$  at  $A$ ,  $E$ ,  $B$ , and  $D$ , as shown in the diagram below. If  $AC:CE = 5:3$ , and  $BD = 56$ , determine and state the length of  $CD$ .

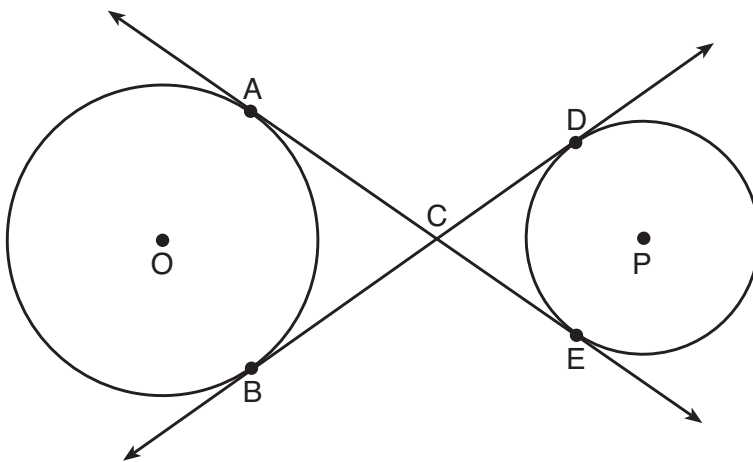

**26** In the diagram below,  $\triangle ABC$  has coordinates  $A(1,1)$ ,  $B(4,1)$ , and  $C(4,5)$ . Graph and label  $\triangle A''B''C''$ , the image of  $\triangle ABC$  after the translation five units to the right and two units up followed by the reflection over the line  $y = 0$ .

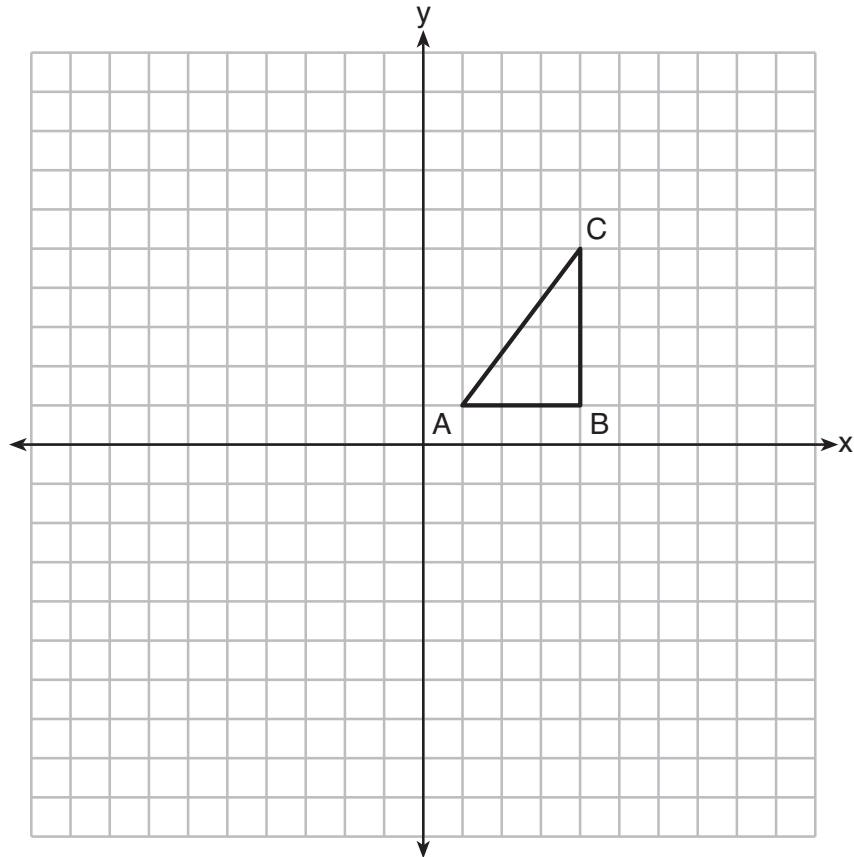

**27** A regular hexagon is rotated in a counterclockwise direction about its center. Determine and state the minimum number of degrees in the rotation such that the hexagon will coincide with itself.

**28** In the diagram of  $\triangle ABC$  shown below, use a compass and straightedge to construct the median to  $\overline{AB}$ . [Leave all construction marks.]

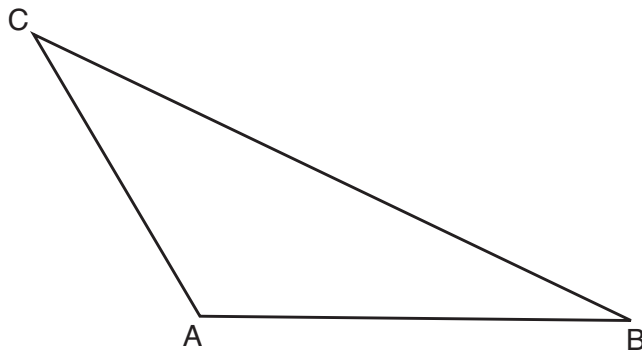

- 29 Triangle  $MNP$  is the image of triangle  $JKL$  after a  $120^\circ$  counterclockwise rotation about point  $Q$ . If the measure of angle  $L$  is  $47^\circ$  and the measure of angle  $N$  is  $57^\circ$ , determine the measure of angle  $M$ . Explain how you arrived at your answer.

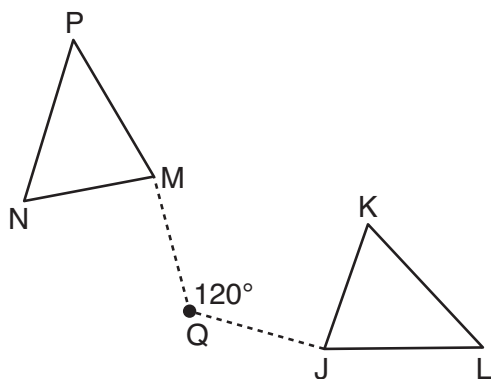

**30** A circle has a center at  $(1,-2)$  and radius of 4. Does the point  $(3.4,1.2)$  lie on the circle? Justify your answer.



- 31** In the diagram below, a window of a house is 15 feet above the ground. A ladder is placed against the house with its base at an angle of  $75^\circ$  with the ground. Determine and state the length of the ladder to the *nearest tenth of a foot*.

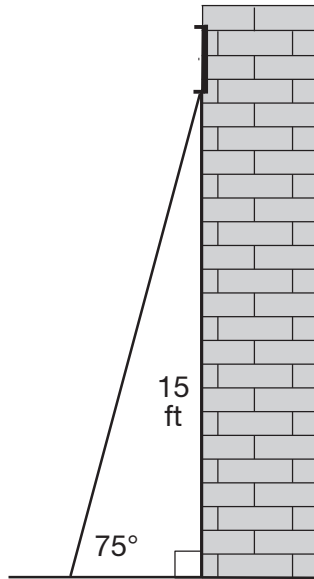

### Part III

Answer all 3 questions in this part. Each correct answer will receive 4 credits. Clearly indicate the necessary steps, including appropriate formula substitutions, diagrams, graphs, charts, etc. Utilize the information provided for each question to determine your answer. Note that diagrams are not necessarily drawn to scale. For all questions in this part, a correct numerical answer with no work shown will receive only 1 credit. All answers should be written in pen, except for graphs and drawings, which should be done in pencil. [12]

- 32 Using a compass and straightedge, construct and label  $\triangle A'B'C'$ , the image of  $\triangle ABC$  after a dilation with a scale factor of 2 and centered at  $B$ . [Leave all construction marks.]

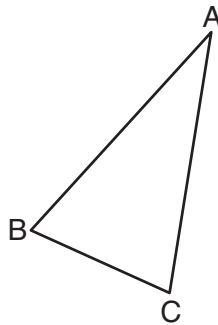

Describe the relationship between the lengths of  $\overline{AC}$  and  $\overline{A'C'}$ .

33 The grid below shows  $\triangle ABC$  and  $\triangle DEF$ .

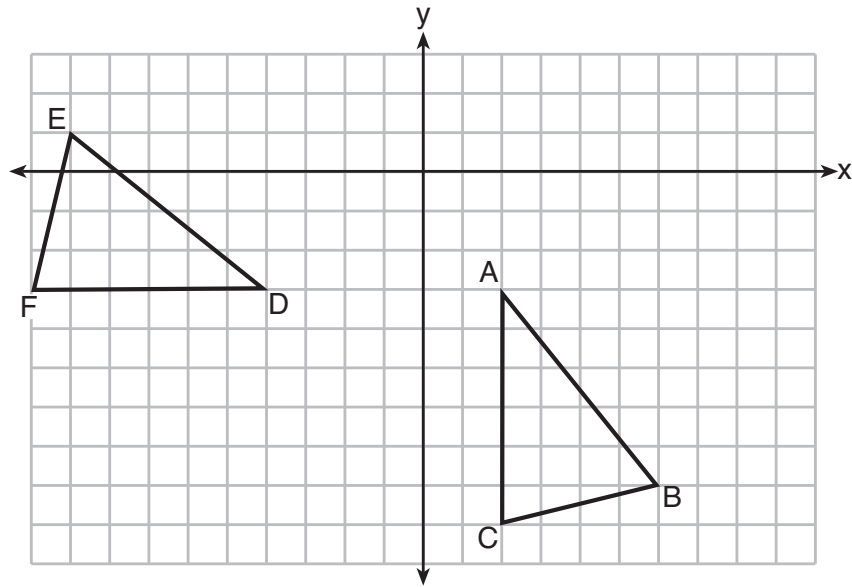

Let  $\triangle A'B'C'$  be the image of  $\triangle ABC$  after a rotation about point A. Determine and state the location of  $B'$  if the location of point  $C'$  is  $(8, -3)$ . Explain your answer.

Is  $\triangle DEF$  congruent to  $\triangle A'B'C'$ ? Explain your answer.

34 As modeled below, a movie is projected onto a large outdoor screen. The bottom of the 60-foot-tall screen is 12 feet off the ground. The projector sits on the ground at a horizontal distance of 75 feet from the screen.

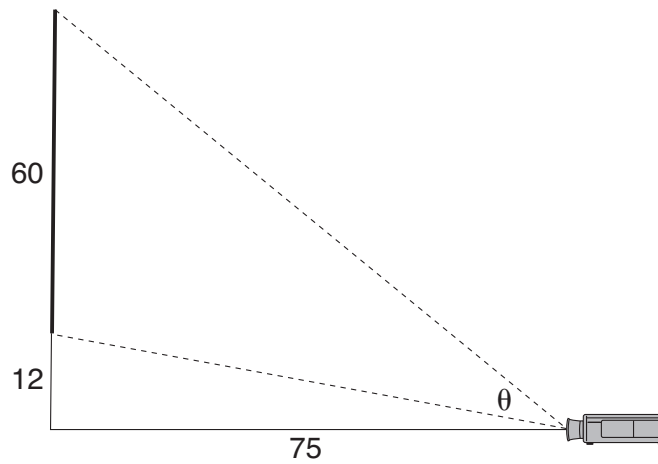

Determine and state, to the *nearest tenth of a degree*, the measure of  $\theta$ , the projection angle.

### Part IV

Answer the 2 questions in this part. Each correct answer will receive 6 credits. Clearly indicate the necessary steps, including appropriate formula substitutions, diagrams, graphs, charts, etc. Utilize the information provided for each question to determine your answer. Note that diagrams are not necessarily drawn to scale. For all questions in this part, a correct numerical answer with no work shown will receive only 1 credit. All answers should be written in pen, except for graphs and drawings, which should be done in pencil. [12]

35 Given: Circle  $O$ , chords  $\overline{AB}$  and  $\overline{CD}$  intersect at  $E$

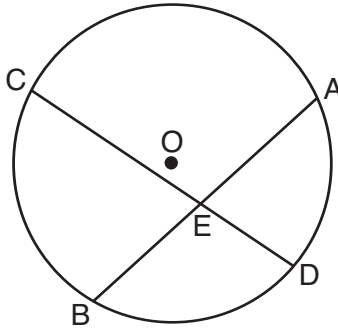

Theorem: If two chords intersect in a circle, the product of the lengths of the segments of one chord is equal to the product of the lengths of the segments of the other chord.

Prove this theorem by proving  $AE \cdot EB = CE \cdot ED$ .

- 36** A snow cone consists of a paper cone completely filled with shaved ice and topped with a hemisphere of shaved ice, as shown in the diagram below. The inside diameter of both the cone and the hemisphere is 8.3 centimeters. The height of the cone is 10.2 centimeters.

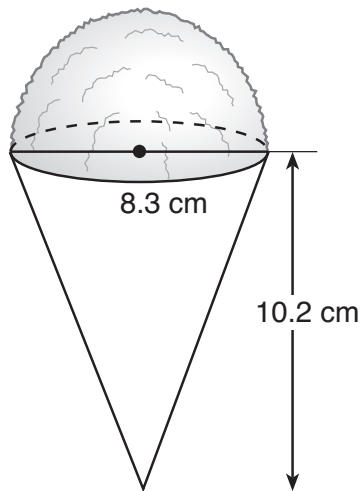

The desired density of the shaved ice is  $0.697 \text{ g/cm}^3$ , and the cost, per kilogram, of ice is \$3.83. Determine and state the cost of the ice needed to make 50 snow cones.